



# Product Specifications

<b>Product Name</b>	Folded Plug Grid 001
<b>Product ID</b>	GRD-FPG-001
<b>Acoustics</b>	0.95 NRC*
<b>Lead Time</b>	Lead time is dependent on project size. Contact us for more information.
<b>Durability</b>	Contract

<b>Warranty</b>	Comes with industry-leading standard warranty.
<b>Flammability</b>	ASTM E84: Class A
<b>Custom</b>	Custom colors and manufacturing services available. Additional charges and lead times may apply.
<b>Maintenance</b>	Vacuum occasionally to remove airborne dust or debris. Mild detergents or soaps may be used to remove stains. For detailed care instructions, refer to the <b>CSI Creative Maintenance Information</b> document.

# Material Specifications

<b>Soundcore®</b>		<b>PoshFelt®</b>
<b>Content</b>	Recycled PET acoustic felt	100% Merino or Karakul wool acoustic felt
<b>Weathering</b>	Colorfast, non-deteriorating, non-hygroscopic	Colorfast, non-deteriorating, non-woven, moisture resistant
<b>Environmental</b>	Recycled PET acoustic felt is 60% post-consumer recycled content and is 100% recyclable. Contributes points toward LEED v4, CDPH v1.2, VOC free, non-toxic, non-allergenic, anti-microbial - does not attract mold and mildew. Compliant with Living Building Challenge criteria & DECLARE Red List Free.	100% organic wool design felt is a rapidly renewable resource and is 100% biodegradable/compostable. Contributes points toward LEED v4, CDPH v1.2, VOC free, no chemical irritants, no formaldehyde, and is free of other harmful substances. Compliant with Living Building Challenge criteria & DECLARE Red List Free.
<b>Variation</b>	PET felt panels are created through a manufacturing process known as 'felting'. This process results in a heathered appearance. Color color tones may appear in the same panel. Slight color variations should be expected.	Due to its 100% natural origin, the raw fibers of wool felt contain inclusions and color variations throughout the material. Color matching is not guaranteed between dye lots and inconsistencies may be more prominent in volumes that exceed the normal commercial standard.

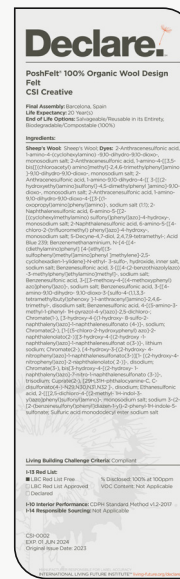
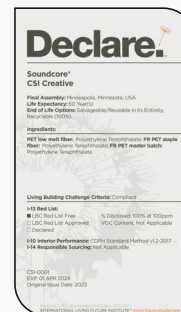

\*Approximate. NRC rating may vary due to product dimensions and spacing.

## Dimensions

### Standard Unit Dimensions

Typical ranges for length and width.

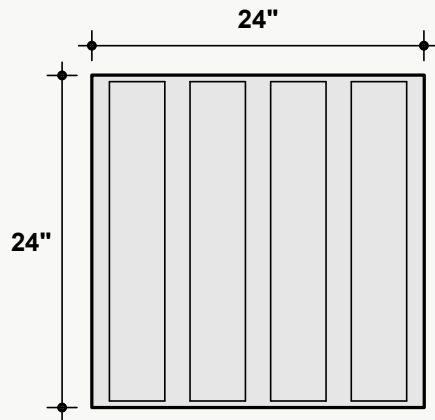

### Standard Unit Thicknesses

Thickness is dependent on material layer selection.

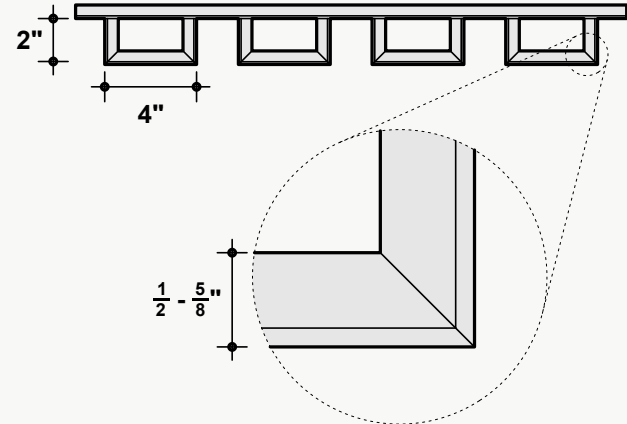

### Custom Opportunity

Product dimensions can be manipulated in order to fit your design aesthetic and site conditions.

# Configuration Options

## Categories

The categories shown represent the available options for this product.

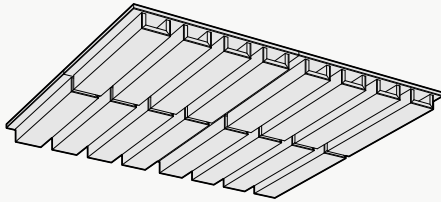

**Aligned**

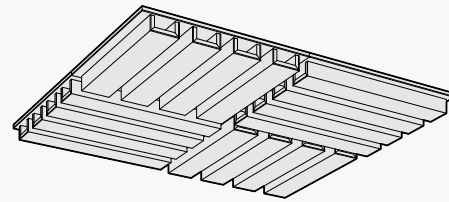

**Rotated**

## Layouts

The layouts shown are a summation of individual units. Individual units may be assembled in various arrangements to dictate the larger design. Configurations shown are suggested, but can be rearranged to achieve a custom layout.

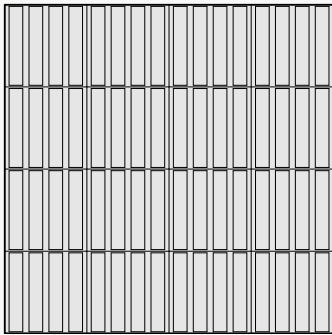

Linear

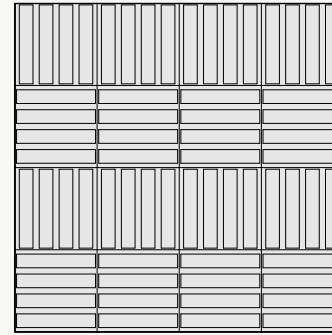

Alternating

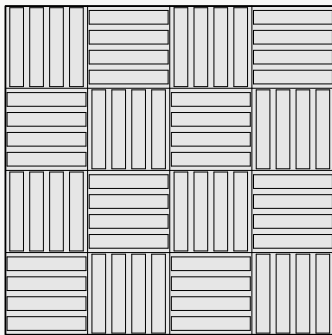

Checkerboard

## Installation Options

All products and installation methods can be **customized** to meet the unique requirements of your space.

### Drop-In

- + Replaces existing mineral tiles
- + Substrate based, no hardware needed

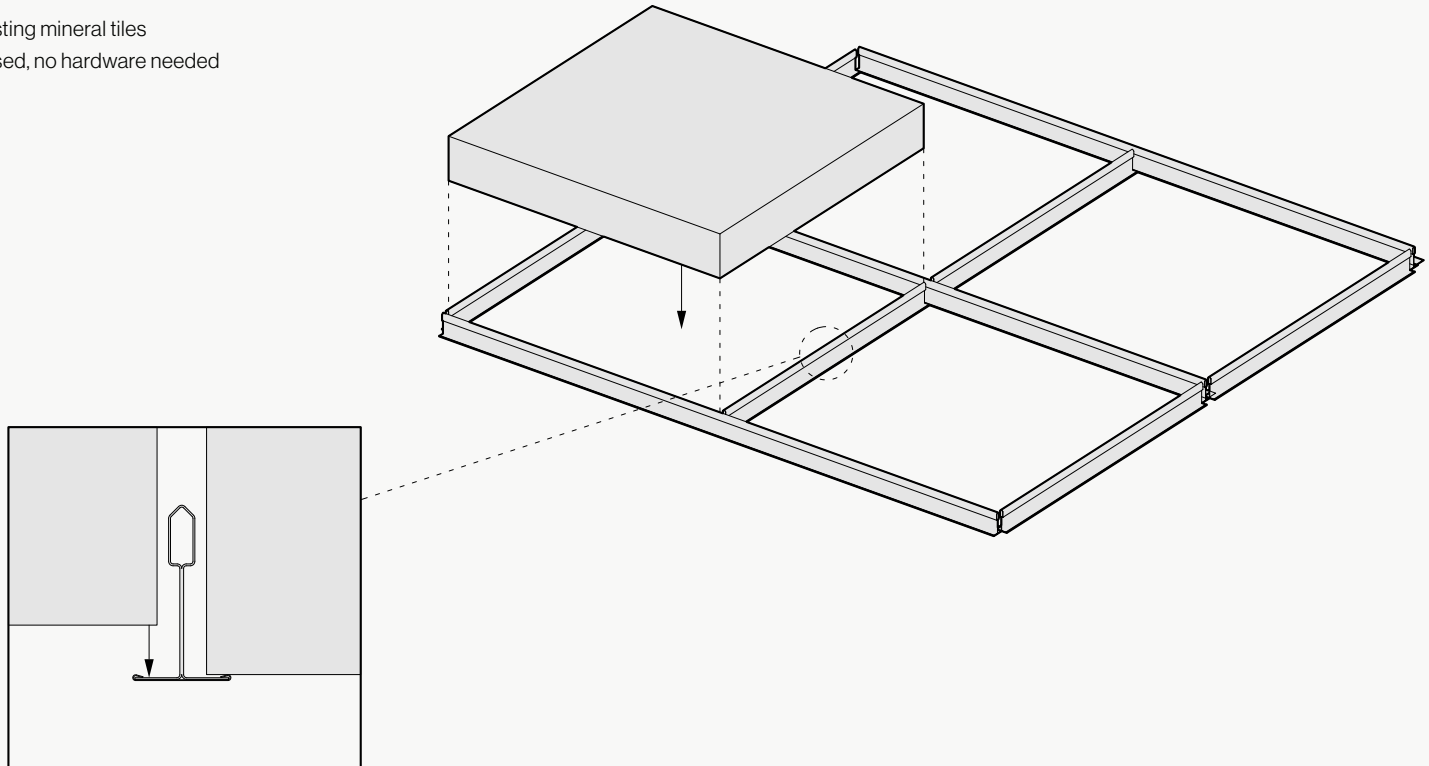

\*Not all listed attachment methods may be applicable to this product.

## Material Layers

### Soundcore®

Our recycled PET felt creates an acoustic barrier, defending against wandering white noise and irritating echoes.

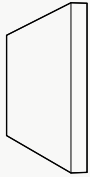

Single Layer  
½" Thickness

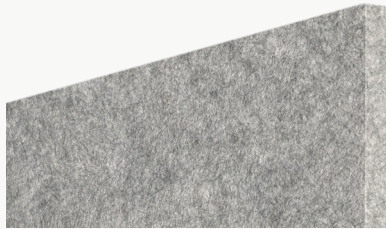

### Soundcore® Wood Textures

Soundcore® wood textures provide the natural aesthetic of wood while maintaining all the acoustic benefits of PET felt. Custom texture opportunities are also available upon request.

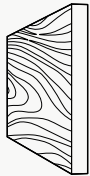

Single Layer  
½" Thickness



### PoshFelt® Exposed Edge



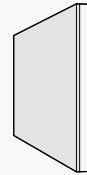



100% organic, natural wool design felt brings out the best experience in your space with color, comfort, and simple sustainability. Exposed edge products leave the Soundcore® layer uncovered, allowing for unique color combinations.

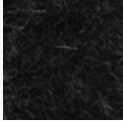
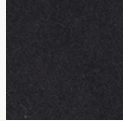
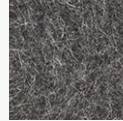

Multi-Layer  
Adds ⅛"-¼" to Material Thickness

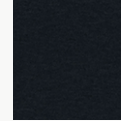
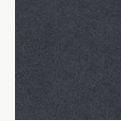
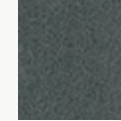
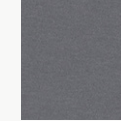
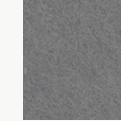
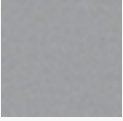
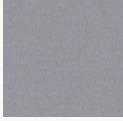
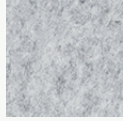
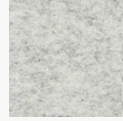
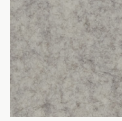
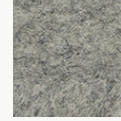
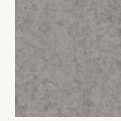
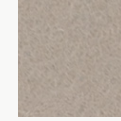
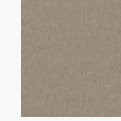
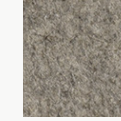

PoshFelt® | 3mm Thickness

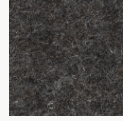
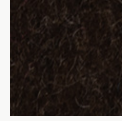
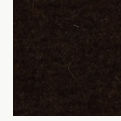
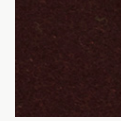
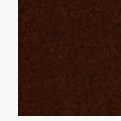
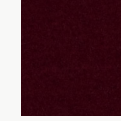
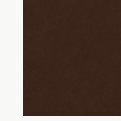
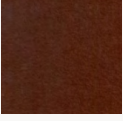
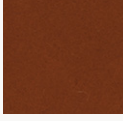
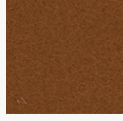
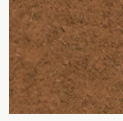
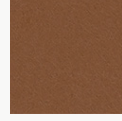
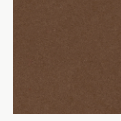
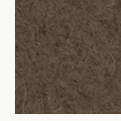
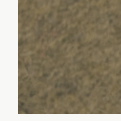
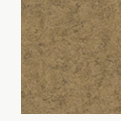
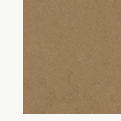
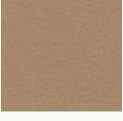
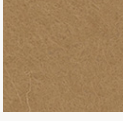
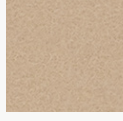
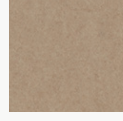
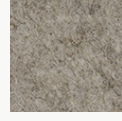
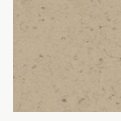
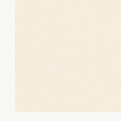
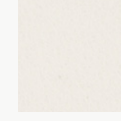
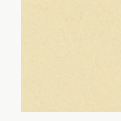
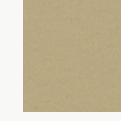
									
PSH005 Black Beauty	PSH161 Black Swan	PSH266 Koala	PSH001 Gray Matter	PSH176 Warmstone	PSH627 Blackberry	PSH265 Slag	PSH513 Gravel	PSH512 Ash Plum	PSH004 Porpoise
									
PSH625 Silver Chain	PSH609 Cityscape	PSH300 Crevasse	PSH299 Mountain Breeze	PSH515 Blizzard	PSH175 Dovetail	PSH624 Dapple Gray	PSH127 Mocha	PSH635 Eggshell	PSH178 Fawn
									
PSH520 Silt	PSH002 Heather	PSH003 Otter	PSH179 Arctic Seal	PSH180 Iron Ore	PSH545 Henna	PSH249 French Press	PSH248 Mink	PSH531 Garnet	PSH146 Auburn
									
PSH521 Cocoa	PSH269 Canyon	PSH253 Toffee	PSH602 Cafe	PSH268 Gingerbread	PSH255 Tropical Walnut	PSH504 Earth	PSH505 Garrigue	PSH503 Savanna	PSH509 Cairo
									
PSH621 Pan	PSH281 Great Plains	PSH291 Gobi	PSH630 Sand Dune	PSH006 Shiitake	PSH519 Cupcake	PSH118 Ivory Lace	PSH174 Cotton	PSH293 Pound Cake	PSH637 Chiffon



PoshFelt® | 3mm Thickness



**PSH304**  
Sugar Cookie



**PSH301**  
Tumbleweed



**PSH541**  
Banana Bread



**PSH622**  
Corn



**PSH215**  
Raincoat



**PSH305**  
Dandelion

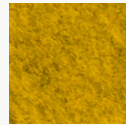

**PSH216**  
Lion's Den



**PSH015**  
Honey



**PSH217**  
Citrine



**PSH507**  
Hive



**PSH634**  
Amber



**PSH261**  
Pale Ale



**PSH638**  
Sunflower



**PSH549**  
Medallion



**PSH295**  
Sunrise Peach



**PSH610**  
Coral



**PSH632**  
Peach



**PSH251**  
Summer Dream



**PSH218**  
Citrus



**PSH532**  
Harvest



**PSH014**  
Knockout Orange



**PSH307**  
Orange Nectar



**PSH633**  
Clementine



**PSH245**  
Fire Agate



**PSH525**  
Olympus



**PSH640**  
Rusted

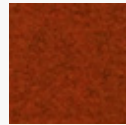

**PSH528**  
Ferrous



**PSH296**  
Paprika



**PSH220**  
Red Earth



**PSH530**  
Hot Iron



**PSH537**  
Cardinal



**PSH535**  
Guppy

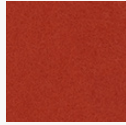

**PSH139**  
Cayenne



**PSH008**  
Bonfire



**PSH308**  
Scarlet

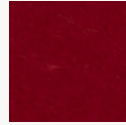

**PSH009**  
Poinsettia



**PSH540**  
Devil's Food



**PSH527**  
Red Velvet



**PSH644**  
Maroon



**PSH539**  
Mahogany

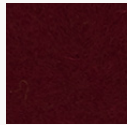

**PSH210**  
Sangria



**PSH211**  
Cherry Chutney

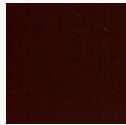

**PSH212**  
Vino

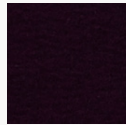

**PSH514**  
Red Wine



**PSH617**  
Evening Gown



**PSH649**  
Pomegranate

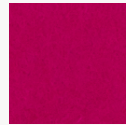

**PSH273**  
Ultraviolet



**PSH137**  
Passion Flower



**PSH272**  
Hotwire



**PSH302**  
Heather Pink

PoshFelt® | 3mm Thickness

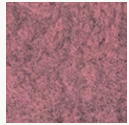

PSH292  
Sakura Mist



PSH202  
Crush



PSH560  
Schiava



PS647  
Eden Rose



PSH643  
Rhododendron

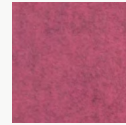

PSH559  
Monroe



PSH544  
Dragonfruit



PSH309  
Allium

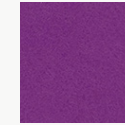

PSH205  
Mulberry

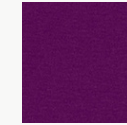

PSH546  
Tyrian Plum



PSH142  
Plum Purple



PSH523  
Violet Sky

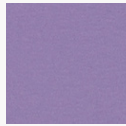

PSH612  
Lilac



PSH286  
Viper

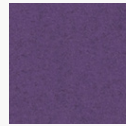

PSH646  
Lupine



PSH274  
Amethyst



PSH275  
Skyfall

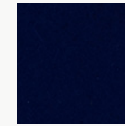

PSH241  
Tranquilo

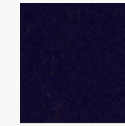

PSH550  
Mariana

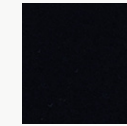

PSH277  
Shade

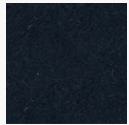

PSH310  
Deep Royal



PSH160  
Admiral Blue



PSH561  
Neptune



PSH239  
Speckled Navy



PSH548  
Ultramarine



PSH645  
Space



PSH508  
Oahu

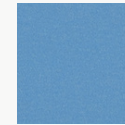

PSH510  
Ozone

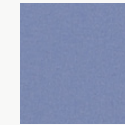

PSH615  
Imagine

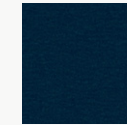

PSH614  
Blueberry

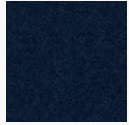

PSH636  
Navy Blue



PSH278  
Squid Ink



PSH260  
Twilight

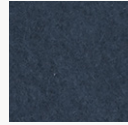

PSH601  
Royalty



PSH616  
Fountain

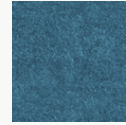

PSH604  
Atlantic

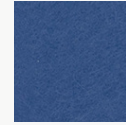

PSH237  
Hotspring



PSH238  
Cobalt

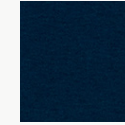

PSH516  
Actun

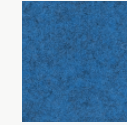

PSH502  
Pacific



PSH511  
Lagoon



PSH152  
Blue Nile



PSH149  
Jamaica Bay



PSH623  
Steel Gray



PSH648  
Aegean



PSH236  
Aquamarine



PSH016  
Freshwater

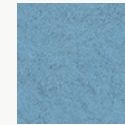

PSH306  
Swell

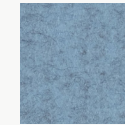

PSH608  
Diamond Dust

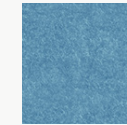

PSH605  
Meander

PoshFelt® | 3mm Thickness



PSH639  
Glacier



PSH606  
Midday



PSH650  
Waterfall



PSH287  
Sea Breeze



PSH628  
Cozumel



PSH631  
Adriatic



PSH552  
Cancun



PSH564  
Jazz



PSH517  
Sky Stone



PSH232  
Seaglass



PSH641  
Basil



PSH629  
Robin's Egg



PSH642  
Blue Spruce



PSH618  
Iguana

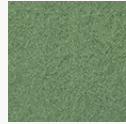

PSH213  
Meadow

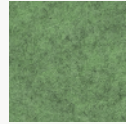

PSH303  
Feather Moss

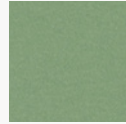

PSH619  
Springtime

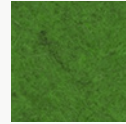

PSH223  
Matrix



PSH164  
Fresh Lime



PSH225  
Everglade



PSH226  
Grove



PSH298  
Peacock

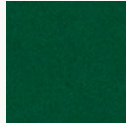

PSH234  
Ocean Trench



PSH311  
Emerald

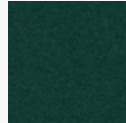

PSH626  
Evergreen

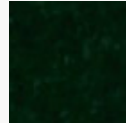

PSH553  
Conifer

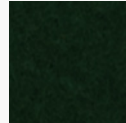

PSH228  
Forest Haze

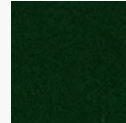

PSH227  
Succulent



PSH563  
Rosemary

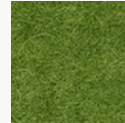

PSH555  
Hemlocks



PSH012  
Shamrock



PSH554  
Cyber Green

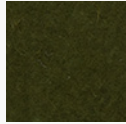

PSH501  
Mire



PSH506  
Bracken



PSH312  
Safari



PSH611  
Haybale



PSH230  
Camouflage

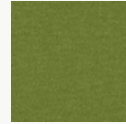

PSH556  
Avocado

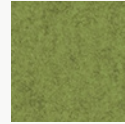

PSH562  
Aurora

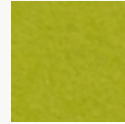

PSH013  
Parakeet

Soundcore® | 1/2" Thickness

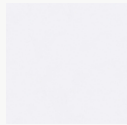

**SND019**  
Linen

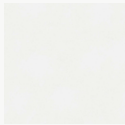

**SND037**  
Paper

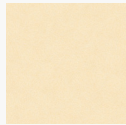

**SND135**  
Oat



**SND105**  
Sand Dollar



**SND109**  
Macadamia



**SND111**  
Lanai



**SND130**  
Buckskin



**SND131**  
Abalone



**SND125**  
Chinchilla

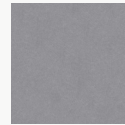

**SND118**  
Anchor



**SND126**  
Wolfhound



**SND110**  
Starry Night



**SND102**  
Morning Fog

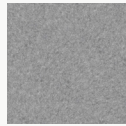

**SND114**  
Lunar Dust

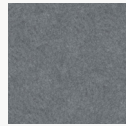

**SND034**  
Granite Peak

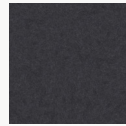

**SND132**  
Cast Iron

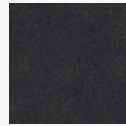

**SND103**  
Storm Cloud



**SND038**  
Inkwell



**SND122**  
Briquette



**SND127**  
Burnt Toast

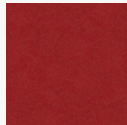

**SND108**  
Ablaze



**SND104**  
Pumpkin



**SND106**  
Goldfinch

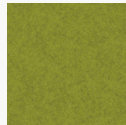

**SND113**  
Gruner

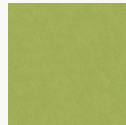

**SND107**  
Grasshopper

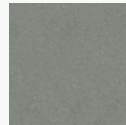

**SND129**  
Dried Thyme

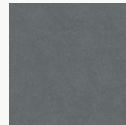

**SND115**  
Mako



**SND112**  
Tulum

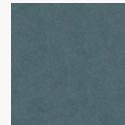

**SND121**  
Apatite

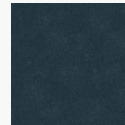

**SND123**  
Chrysocolla



**SND117**  
Serene



**SND124**  
Ice Floe

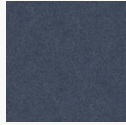

**SND128**  
Arctic Ocean



**SND133**  
Galactic



**SND116**  
Blue Marlin

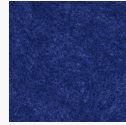

**SND101**  
Commodore



**SND042**  
Denim

Soundcore® Wood Textures | 1/2" Thickness



**SND716**  
Dark Teak



**SND792**  
Dark Oak



**SND715**  
Dark Cherry



**SND793**  
Vintage Maple



**SND794**  
Warm Teak

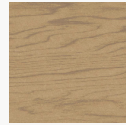

**SND714**  
English Walnut



**SND713**  
Honey Walnut



**SND717**  
Warm Oak



**SND790**  
Natural Teak

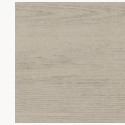

**SND712**  
Natural Spruce



**SND711**  
Bleached Cherry



**SND795**  
Light Teak



**SND709**  
White Maple

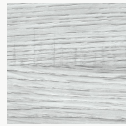

**SND791**  
Gray Oak



**SND710**  
Gray Teak