

# Product Specifications

<b>Product Name</b>	Single Baffles 003
<b>Product ID</b>	BFL-SGL-003
<b>Acoustics</b>	0.40 - 0.85 NRC*
<b>Lead Time</b>	Lead time is dependent on project size. Contact us for more information.
<b>Durability</b>	Contract

<b>Warranty</b>	Comes with industry-leading standard warranty.
<b>Flammability</b>	ASTM E84: Class A
<b>Custom</b>	Custom colors and manufacturing services available. Additional charges and lead times may apply.
<b>Maintenance</b>	Vacuum occasionally to remove airborne dust or debris. Mild detergents or soaps may be used to remove stains. For detailed care instructions, refer to the <b>CSI Creative Maintenance Information</b> document.

# Material Specifications

	<b>Soundcore®</b>	<b>PoshFelt®</b>
<b>Content</b>	Recycled PET acoustic felt	100% Merino or Karakul wool acoustic felt
<b>Weathering</b>	Colorfast, non-deteriorating, non-hygroscopic	Colorfast, non-deteriorating, non-woven, moisture resistant
<b>Environmental</b>	Recycled PET acoustic felt is 60% post-consumer recycled content and is 100% recyclable. Contributes points toward LEED v4, CDPH v1.2, VOC free, non-toxic, non-allergenic, anti-microbial - does not attract mold and mildew. Compliant with Living Building Challenge criteria & DECLARE Red List Free.	100% organic wool design felt is a rapidly renewable resource and is 100% biodegradable/compostable. Contributes points toward LEED v4, CDPH v1.2, VOC free, no chemical irritants, no formaldehyde, and is free of other harmful substances. Compliant with Living Building Challenge criteria & DECLARE Red List Free.
<b>Variation</b>	PET felt panels are created through a manufacturing process known as 'felting'. This process results in a heathered appearance. Multiple color tones may appear in the same panel. Slight color variations should be expected.	Due to its 100% natural origin, the raw fibers of wool felt contain inclusions and color variations throughout the material. Color matching is not guaranteed between dye lots and inconsistencies may be more prominent in volumes that exceed the normal commercial standard.



\*Approximate. NRC rating may vary due to product dimensions and spacing.

## Dimensions

### Standard Unit Dimensions

Typical ranges for length and height.

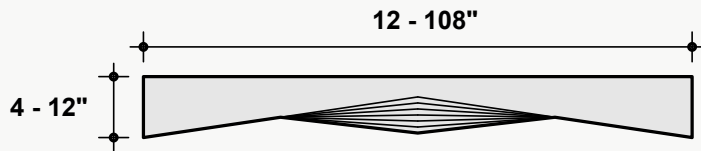

### Custom Opportunity

Product dimensions can be manipulated in order to fit your design aesthetic and site conditions.

### Standard Unit Thicknesses

Thickness is dependent on material layer selection.

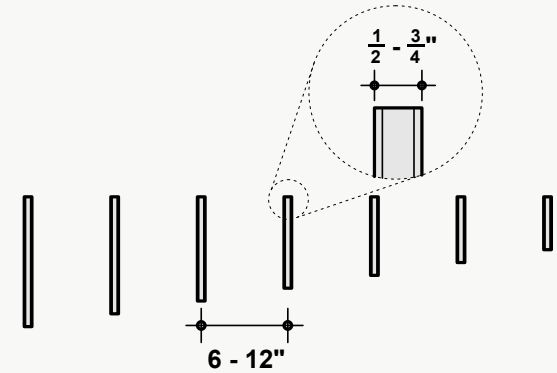

### On-Center Spacing

Our standard product spacing is 6"-12" on-center. Acoustic performance of the product improves as spacing is reduced.

## Product Details

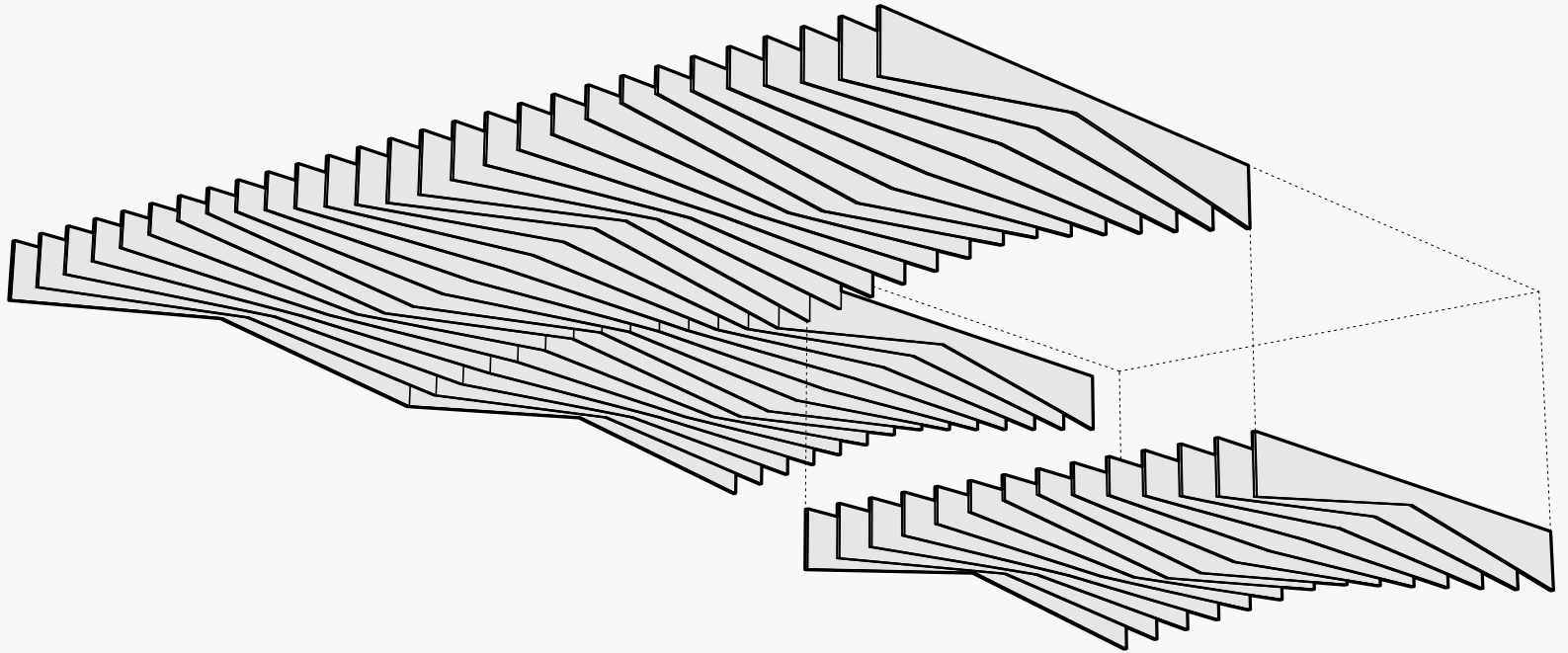

# Installation Options

All products and installation methods can be **customized** to meet the unique requirements of your space.

## Rail Suspension Advantages

Rail suspension installation methods are designed for fast and easy installation by reducing the amount of suspension points. The rail structure acts as a guide for the baffles, maintaining baffle spacing and orientation while remaining easily customizable to fit most RCP layouts.

Pre-Defined Spacing

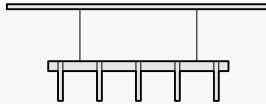

Consistent Angle

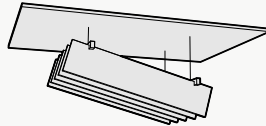

Non-Perpendicular Arrangements

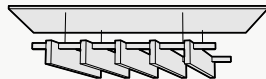

## Individual Suspension Advantages

Individual suspension installation methods excel at accommodating irregular layouts. They are the most versatile installation style, and can be customized to fit even the most unique RCP layout.

Height Variation

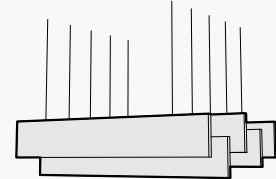

Angle Variation

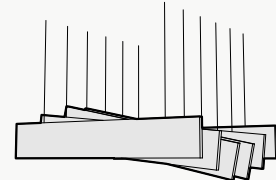

Non-Linear Arrangements

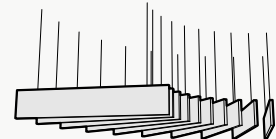

## Attachment Methods\*

### Rail Suspension

#### Aircraft Cable

- + Fastest/easiest height adjustment
- + Largest height adjustment range
- + Height and angle versatility
- + Accommodates uneven ceiling surfaces and MEP

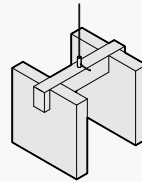

### Individual Suspension

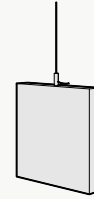

#### Threaded Rod

- + Reduced product sway
- + Height and angle versatility
- + Accommodates uneven ceiling surfaces and MEP

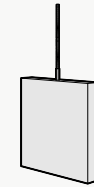
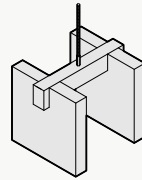

#### Mechanical Direct

- + Lowest profile installation method
- + Eliminates product sway
- + Connects to: Unistrut, ACT Grid, flat ceiling surfaces
- + Connections: Magnets, Grid Clips, Panel Clips, Metal Bracket, Custom

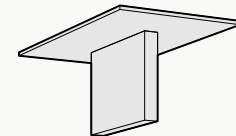
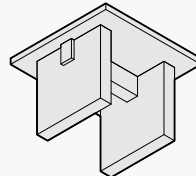

\*Not all listed attachment methods may be applicable to this product.

## Material Layers

### Soundcore®

Our recycled PET felt creates an acoustic barrier, defending against wandering white noise and irritating echoes.

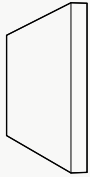

Single Layer  
½" Thickness

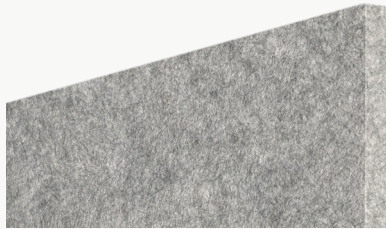

### Soundcore® Wood Textures

Soundcore® wood textures provide the natural aesthetic of wood while maintaining all the acoustic benefits of PET felt. Custom texture opportunities are also available upon request.

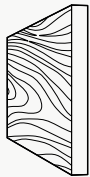

Single Layer  
½" Thickness



### PoshFelt® Exposed Edge

100% organic, natural wool design felt brings out the best experience in your space with color, comfort, and simple sustainability. Exposed edge products leave the Soundcore® layer uncovered, allowing for unique color combinations.

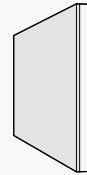

Multi-Layer  
Adds ⅛"-¼" to Material Thickness



PoshFelt® | 3mm Thickness



**PSH005**  
Black Beauty

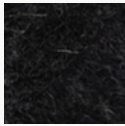

**PSH161**  
Black Swan



**PSH266**  
Koala

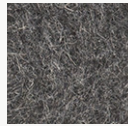

**PSH001**  
Gray Matter

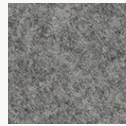

**PSH176**  
Warmstone

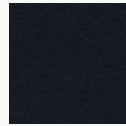

**PSH627**  
Blackberry



**PSH265**  
Slag

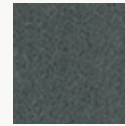

**PSH513**  
Gravel

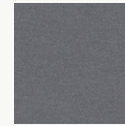

**PSH512**  
Ash Plum

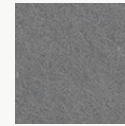

**PSH004**  
Porpoise

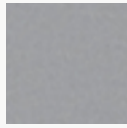

**PSH625**  
Silver Chain

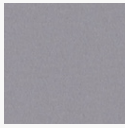

**PSH609**  
Cityscape



**PSH300**  
Crevasse

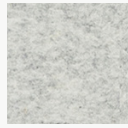

**PSH299**  
Mountain Breeze



**PSH515**  
Blizzard



**PSH175**  
Dovetail



**PSH624**  
Dapple Gray

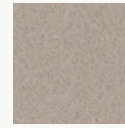

**PSH127**  
Mocha

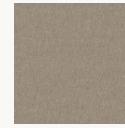

**PSH635**  
Eggshell



**PSH178**  
Fawn



**PSH520**  
Silt

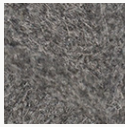

**PSH002**  
Heather

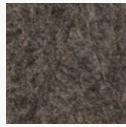

**PSH003**  
Otter

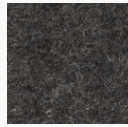

**PSH179**  
Arctic Seal

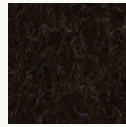

**PSH180**  
Iron Ore



**PSH545**  
Henna

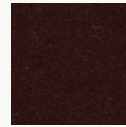

**PSH249**  
French Press



**PSH248**  
Mink

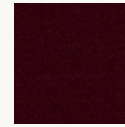

**PSH531**  
Garnet



**PSH146**  
Auburn

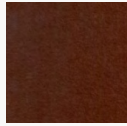

**PSH521**  
Cocoa



**PSH269**  
Canyon



**PSH253**  
Toffee



**PSH602**  
Cafe



**PSH268**  
Gingerbread



**PSH255**  
Tropical Walnut

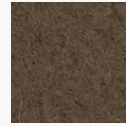

**PSH504**  
Earth



**PSH505**  
Garrigue



**PSH503**  
Savanna



**PSH509**  
Cairo

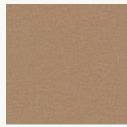

**PSH621**  
Pan



**PSH281**  
Great Plains



**PSH291**  
Gobi



**PSH630**  
Sand Dune



**PSH006**  
Shiitake

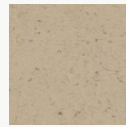

**PSH519**  
Cupcake

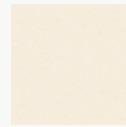

**PSH118**  
Ivory Lace

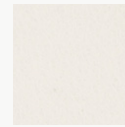

**PSH174**  
Cotton

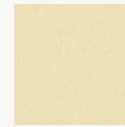

**PSH293**  
Pound Cake

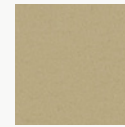

**PSH637**  
Chiffon



PoshFelt® | 3mm Thickness

									
PSH304 Sugar Cookie	PSH301 Tumbleweed	PSH541 Banana Bread	PSH622 Corn	PSH215 Raincoat	PSH305 Dandelion	PSH216 Lion's Den	PSH015 Honey	PSH217 Citrine	PSH507 Hive
									
PSH634 Amber	PSH261 Pale Ale	PSH638 Sunflower	PSH549 Medallion	PSH295 Sunrise Peach	PSH610 Coral	PSH632 Peach	PSH251 Summer Dream	PSH218 Citrus	PSH532 Harvest
									
PSH014 Knockout Orange	PSH307 Orange Nectar	PSH633 Clementine	PSH245 Fire Agate	PSH525 Olympus	PSH640 Rusted	PSH528 Ferrous	PSH296 Paprika	PSH220 Red Earth	PSH530 Hot Iron
									
PSH537 Cardinal	PSH535 Guppy	PSH139 Cayenne	PSH008 Bonfire	PSH308 Scarlet	PSH009 Poinsettia	PSH540 Devil's Food	PSH527 Red Velvet	PSH644 Maroon	PSH539 Mahogany
									
PSH210 Sangria	PSH211 Cherry Chutney	PSH212 Vino	PSH514 Red Wine	PSH617 Evening Gown	PSH649 Pomegranate	PSH273 Ultraviolet	PSH137 Passion Flower	PSH272 Hotwire	PSH302 Heather Pink

PoshFelt® | 3mm Thickness

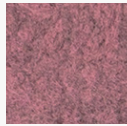

PSH292  
Sakura Mist



PSH202  
Crush



PSH560  
Schiava



PS647  
Eden Rose



PSH643  
Rhododendron

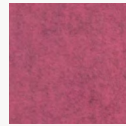

PSH559  
Monroe



PSH544  
Dragonfruit



PSH309  
Allium



PSH205  
Mulberry



PSH546  
Tyrian Plum



PSH142  
Plum Purple



PSH523  
Violet Sky

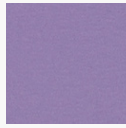

PSH612  
Lilac



PSH286  
Viper

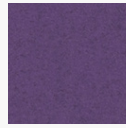

PSH646  
Lupine



PSH274  
Amethyst



PSH275  
Skyfall



PSH241  
Tranquilo

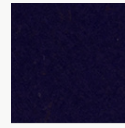

PSH550  
Mariana

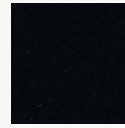

PSH277  
Shade

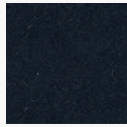

PSH310  
Deep Royal

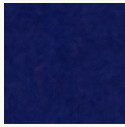

PSH160  
Admiral Blue



PSH561  
Neptune



PSH239  
Speckled Navy



PSH548  
Ultramarine

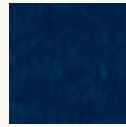

PSH645  
Space

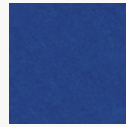

PSH508  
Oahu



PSH510  
Ozone

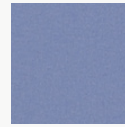

PSH615  
Imagine



PSH614  
Blueberry



PSH636  
Navy Blue



PSH278  
Squid Ink



PSH260  
Twilight

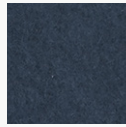

PSH601  
Royalty



PSH616  
Fountain

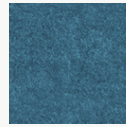

PSH604  
Atlantic



PSH237  
Hotspring



PSH238  
Cobalt



PSH516  
Actun



PSH502  
Pacific



PSH511  
Lagoon



PSH152  
Blue Nile



PSH149  
Jamaica Bay



PSH623  
Steel Gray



PSH648  
Aegean



PSH236  
Aquamarine



PSH016  
Freshwater

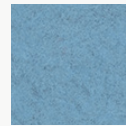

PSH306  
Swell

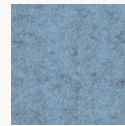

PSH608  
Diamond Dust

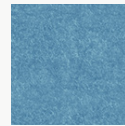

PSH605  
Meander

PoshFelt® | 3mm Thickness



PSH639  
Glacier



PSH606  
Midday



PSH650  
Waterfall



PSH287  
Sea Breeze



PSH628  
Cozumel



PSH631  
Adriatic



PSH552  
Cancun



PSH564  
Jazz



PSH517  
Sky Stone



PSH232  
Seaglass

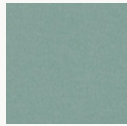

PSH641  
Basil



PSH629  
Robin's Egg



PSH642  
Blue Spruce



PSH618  
Iguana

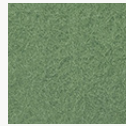

PSH213  
Meadow

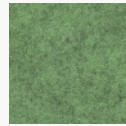

PSH303  
Feather Moss

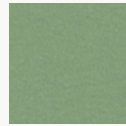

PSH619  
Springtime

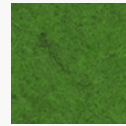

PSH223  
Matrix



PSH164  
Fresh Lime



PSH225  
Everglade



PSH226  
Grove



PSH298  
Peacock



PSH234  
Ocean Trench



PSH311  
Emerald

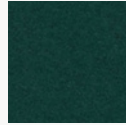

PSH626  
Evergreen



PSH553  
Conifer

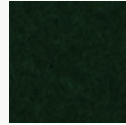

PSH228  
Forest Haze



PSH227  
Succulent



PSH563  
Rosemary



PSH555  
Hemlocks



PSH012  
Shamrock



PSH554  
Cyber Green



PSH501  
Mire



PSH506  
Bracken



PSH312  
Safari



PSH611  
Haybale

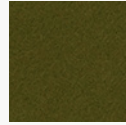

PSH230  
Camouflage

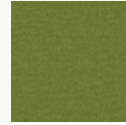

PSH556  
Avocado

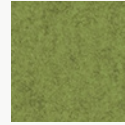

PSH562  
Aurora

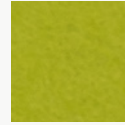

PSH013  
Parakeet

Soundcore® | 1/2" Thickness

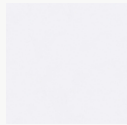

**SND019**  
Linen

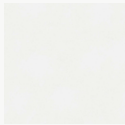

**SND037**  
Paper

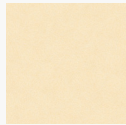

**SND135**  
Oat



**SND105**  
Sand Dollar



**SND109**  
Macadamia



**SND111**  
Lanai



**SND130**  
Buckskin



**SND131**  
Abalone



**SND125**  
Chinchilla

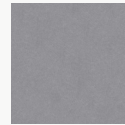

**SND118**  
Anchor



**SND126**  
Wolfhound



**SND110**  
Starry Night



**SND102**  
Morning Fog

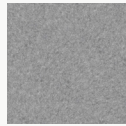

**SND114**  
Lunar Dust

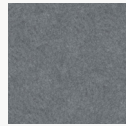

**SND034**  
Granite Peak

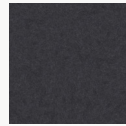

**SND132**  
Cast Iron

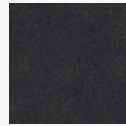

**SND103**  
Storm Cloud



**SND038**  
Inkwell



**SND122**  
Briquette



**SND127**  
Burnt Toast

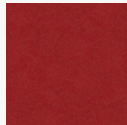

**SND108**  
Ablaze



**SND104**  
Pumpkin



**SND106**  
Goldfinch

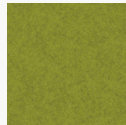

**SND113**  
Gruner

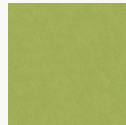

**SND107**  
Grasshopper

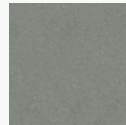

**SND129**  
Dried Thyme

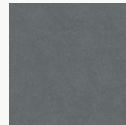

**SND115**  
Mako



**SND112**  
Tulum

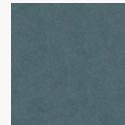

**SND121**  
Apatite

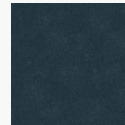

**SND123**  
Chrysocolla



**SND117**  
Serene



**SND124**  
Ice Floe

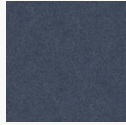

**SND128**  
Arctic Ocean



**SND133**  
Galactic



**SND116**  
Blue Marlin

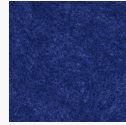

**SND101**  
Commodore



**SND042**  
Denim

Soundcore® Wood Textures | 1/2" Thickness



**SND716**  
Dark Teak



**SND792**  
Dark Oak



**SND715**  
Dark Cherry



**SND793**  
Vintage Maple



**SND794**  
Warm Teak

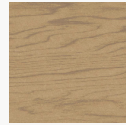

**SND714**  
English Walnut



**SND713**  
Honey Walnut



**SND717**  
Warm Oak



**SND790**  
Natural Teak

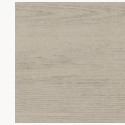

**SND712**  
Natural Spruce



**SND711**  
Bleached Cherry



**SND795**  
Light Teak



**SND709**  
White Maple



**SND791**  
Gray Oak



**SND710**  
Gray Teak