



# Product Specifications

<b>Product Name</b>	Waffle Folded Clouds 003
<b>Product ID</b>	CLD-WFD-003
<b>Acoustics</b>	0.40 - 0.85 NRC*
<b>Lead Time</b>	Lead time is dependent on project size. Contact us for more information.
<b>Durability</b>	Contract

<b>Warranty</b>	Comes with industry-leading standard warranty.
<b>Flammability</b>	ASTM E84: Class A
<b>Custom</b>	Custom colors and manufacturing services available. Additional charges and lead times may apply.
<b>Maintenance</b>	Vacuum occasionally to remove airborne dust or debris. Mild detergents or soaps may be used to remove stains. For detailed care instructions, refer to the <b>CSI Creative Maintenance Information</b> document.

# Material Specifications

<b>Soundcore®</b>	
<b>Content</b>	Recycled PET acoustic felt
<b>Weathering</b>	Colorfast, non-deteriorating, non-hygroscopic
<b>Environmental</b>	Recycled PET acoustic felt is 60% post-consumer recycled content and is 100% recyclable. Contributes points toward LEED v4. CDPH v1.2. VOC free, non-toxic, non-allergenic, anti-microbial - does not attract mold and mildew. Compliant with Living Building Challenge criteria & DECLARE Red List Free.
<b>Variation</b>	PET felt panels are created through a manufacturing process known as 'felting'. This process results in a heathered appearance. Multiple color tones may appear in the same panel. Slight color variations should be expected.

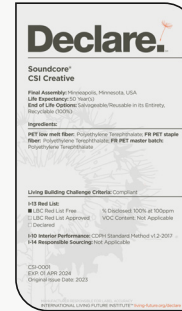

\*Approximate. NRC rating may vary due to product dimensions and spacing.

## Dimensions

### Standard Unit Dimensions

Typical ranges for length and width.

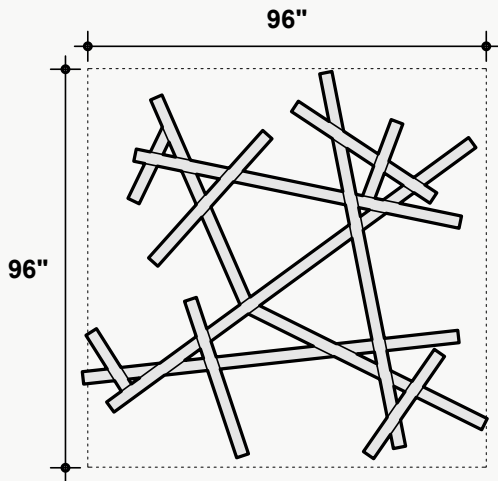

### Standard Unit Thicknesses

Thickness is independent of material layer selection.

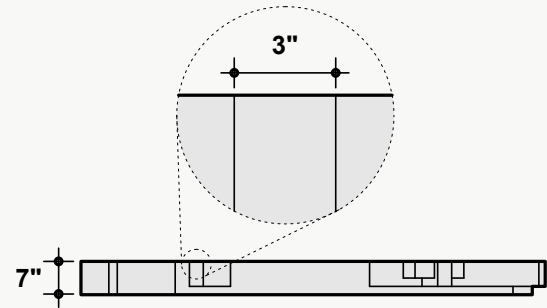

### Custom Opportunity

Product dimensions can be manipulated in order to fit your design aesthetic and site conditions.

## Product Details

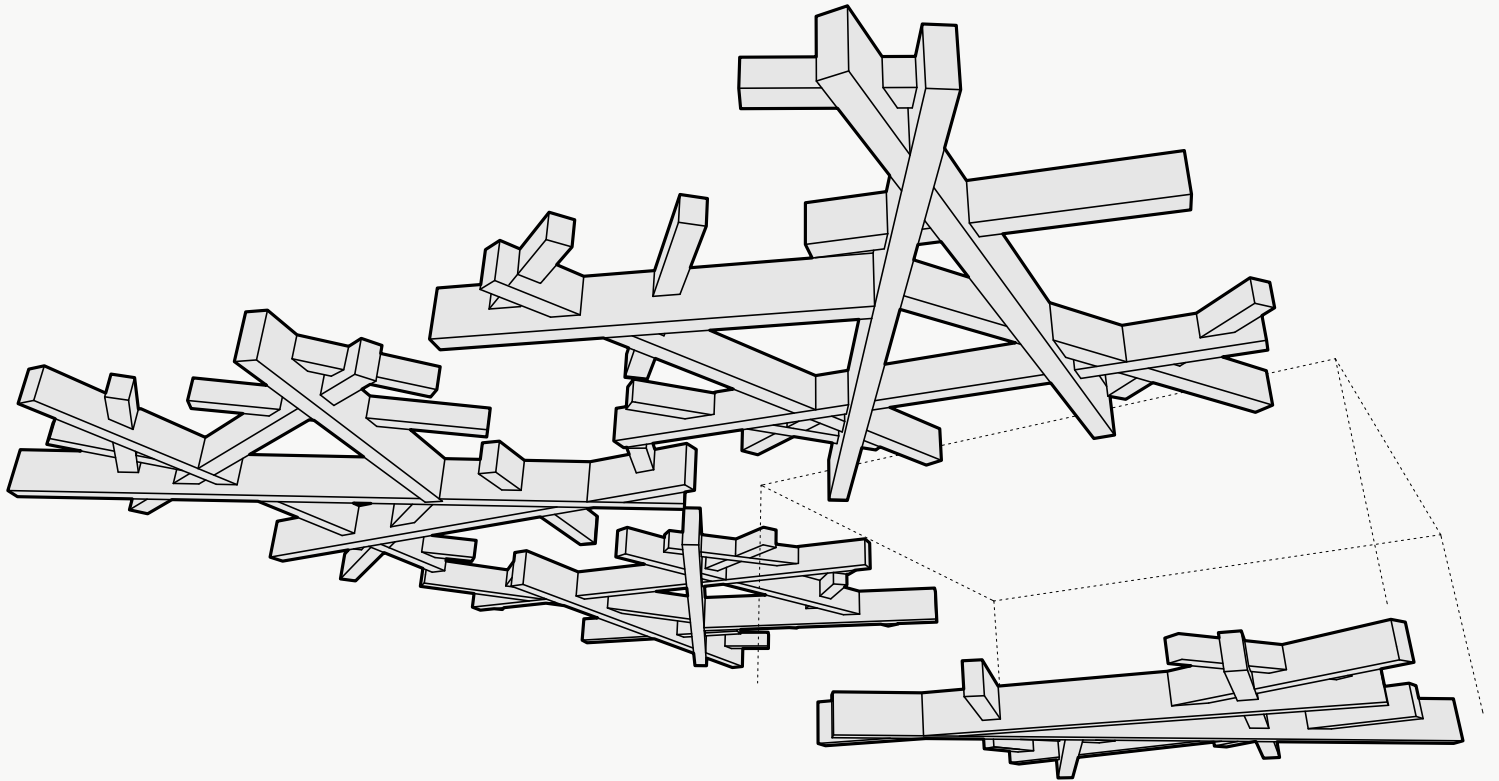

## Attachment Methods\*

### Aircraft Cable

- + Fastest/easiest height adjustment
- + Largest height adjustment range
- + Height and angle versatility
- + Accommodates uneven ceiling surfaces and MEP

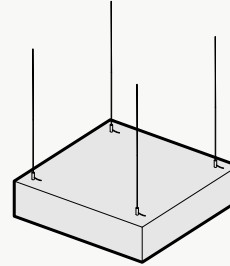

### Threaded Rod

- + Reduced product sway
- + Height and angle versatility
- + Accommodates uneven ceiling surfaces and MEP

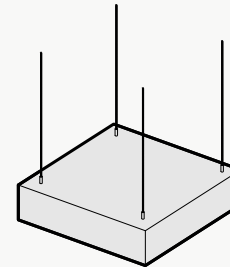

### Mechanical Direct

- + Lowest profile installation method
- + Eliminates product sway
- + Connects to: Unistrut, ACT Grid, flat ceiling surfaces
- + Connections: Magnets, Grid Clips, Panel Clips, Metal Bracket, Custom

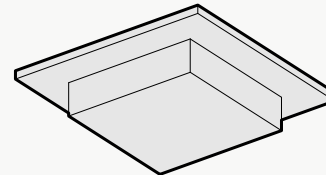

\*Not all listed attachment methods may be applicable to this product.

## Material Layers

### Soundcore®

Our recycled PET felt creates an acoustic barrier, defending against wandering white noise and irritating echoes.

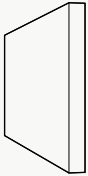

Single Layer  
½" Thickness

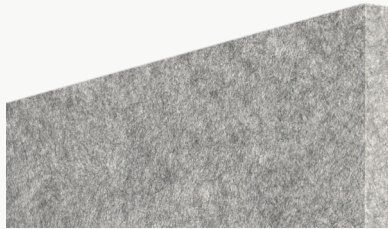

### Soundcore® Wood Textures

Soundcore® wood textures provide the natural aesthetic of wood while maintaining all the acoustic benefits of PET felt. Custom texture opportunities are also available upon request.



Single Layer  
½" Thickness



Soundcore® | 1/2" Thickness

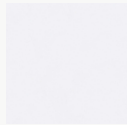

SND019  
Linen

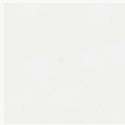

SND037  
Paper



SND134  
Oat



SND135  
Vanilla Bean



SND105  
Sand Dollar



SND109  
Macadamia



SND111  
Lanai



SND130  
Buckskin



SND131  
Abalone

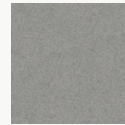

SND125  
Chinchilla

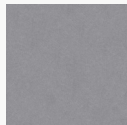

SND118  
Anchor

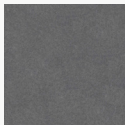

SND126  
Wolfhound

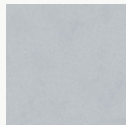

SND110  
Starry Night

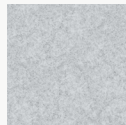

SND102  
Morning Fog

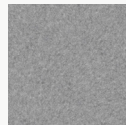

SND114  
Lunar Dust

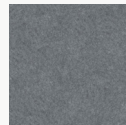

SND034  
Granite Peak

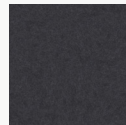

SND132  
Cast Iron

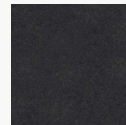

SND103  
Storm Cloud



SND038  
Inkwell



SND122  
Briquette



SND127  
Burnt Toast



SND108  
Ablaze



SND104  
Pumpkin



SND106  
Goldfinch

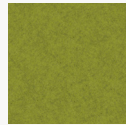

SND113  
Gruner



SND107  
Grasshopper

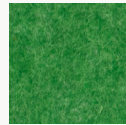

SND136  
Clover

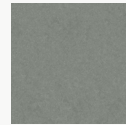

SND129  
Dried Thyme

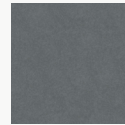

SND115  
Mako

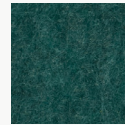

SND137  
Cove



SND112  
Tulum



SND121  
Apatite

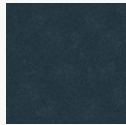

SND123  
Chrysocolla



SND117  
Serene



SND124  
Ice Floe

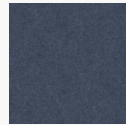

SND128  
Arctic Ocean

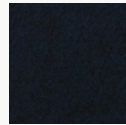

SND133  
Galactic



SND116  
Blue Marlin

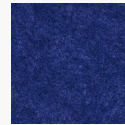

SND101  
Commodore

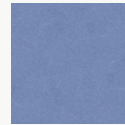

SND042  
Denim

Soundcore® Wood Textures | 1/2" Thickness



**SND716**  
Dark Teak



**SND792**  
Dark Oak



**SND715**  
Dark Cherry



**SND793**  
Vintage Maple



**SND794**  
Warm Teak



**SND714**  
English Walnut



**SND713**  
Honey Walnut



**SND717**  
Warm Oak



**SND790**  
Natural Teak

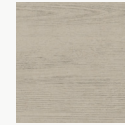

**SND712**  
Natural Spruce



**SND711**  
Bleached Cherry



**SND795**  
Light Teak



**SND709**  
White Maple

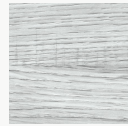

**SND791**  
Gray Oak

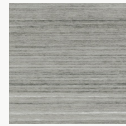

**SND710**  
Gray Teak